

# SWIMMING POOL HEAT PUMP UNIT

## Installation & Instruction Manual





# CONTENTS

1. Preface .....	1
2. Specifications .....	2
2.1 Performance Data of Swimming Pool Heat Pump Unit .....	2
2.2 The Dimensions for Swimming Pool Heat Pump Unit .....	3
3. Installation and Connection .....	4
3.1 Installation illustration .....	4
3.2 Swimming Pool Heat Pumps Location .....	5
3.3 How Close to Your Pool? .....	5
3.4 Swimming Pool Heat Pumps Plumbing .....	6
3.5 Swimming Pool Heat Pumps Electrical Wiring .....	7
3.6 Initial Startup of the Unit .....	7
4. Usage and Operation .....	8
4.1 Function of the controller .....	8
4.2 Usage of the controller .....	10
4.3 Parameter table .....	17
5. Maintenance and Inspection .....	18
6. Appendix .....	19
6.1 Connection of PCB illustration .....	19
6.2 Explosive view of the unit .....	22

# 1. PREFACE

---

- In order to provide our customers with quality, reliability and versatility, this product has been made to strict production standards. This manual includes all the necessary information about installation, debugging, discharging and maintenance. Please read this manual carefully before you open or maintain the unit. The manufacture of this product will not be held responsible if someone is injured or the unit is damaged, as a result of improper installation, debugging, or unnecessary maintenance. It is vital that the instructions within this manual are adhered to at all times. The unit must be installed by qualified personnel.
- The unit can only be repaired by qualified installer centre, personnel or an authorised dealer.
- Maintenance and operation must be carried out according to the recommended time and frequency, as stated in this manual.
- Use genuine standard spare parts only.  
Failure to comply with these recommendations will invalidate the warranty.
- Swimming Pool Heat Pump Unit heats the swimming pool water and keeps the temperature constant. For split type unit, The indoor unit can be Discretely hidden or semi-hidden to suit a luxury house.

Our heat pump has following characteristics:

## 1 Durable

The heat exchanger is made of PVC & Copper Nickle tube which can withstand prolonged exposure to swimming pool water.

## 2 Installation flexibility

The unit can be installed outdoors or indoors.

## 3 Quiet operation

The unit comprises an efficient rotary/ scroll compressor and a low-noise fan motor, which guarantees its quiet operation.

## 4 Advanced controlling

The unit includes micro-computer controlling, allowing all operation parameters to be set. Operation status can be displayed on the LCD wire controller. Remote controller can be chosen as future option.

## 2.SPECIFICATION

---

### 2.1 Performance data of Swimming Pool Heat Pump Unit

\*\*\* REFRIGERANT : R410A

Unit	Model	Oasis X19	Oasis X24
Heating Capacity	kW	19.3	26.10
	BTU/h	65620	88740
Heating Power Input	kW	3.01	4.06
Running Current	A	13.0	17.5
Power Supply		230V~/50Hz	230V~/50Hz
Compressor Quantity		1	1
Compressor		rotary	Scroll
Fan Quantity		1	1
Fan Power Input	W	150	150
Fan Rotate Speed	RPM	850	850
Fan Direction		horizontal	horizontal
Noise	dB(A)	56	56
Water Connection	mm	40	40
Water Flow Volume	m <sup>3</sup> /h	6	7.0
Water Pressure Drop(max)	kPa	3.5	12
Unit Net Dimensions(L/W/H)	mm	1156×487×867	1115×455×868
Unit Shipping Dimensions(L/W/H)	mm	1210×510×880	1200×480×880
Net Weight	kg	83	108
Shipping Weight	kg	98	123

Heating: Outdoor air temp:24°C/19°C, Inlet water temp:26°C

## 2.SPECIFICATION

### 2.2 The dimensions for Swimming Pool Heat Pump Unit

Models: Oasis X19/X24

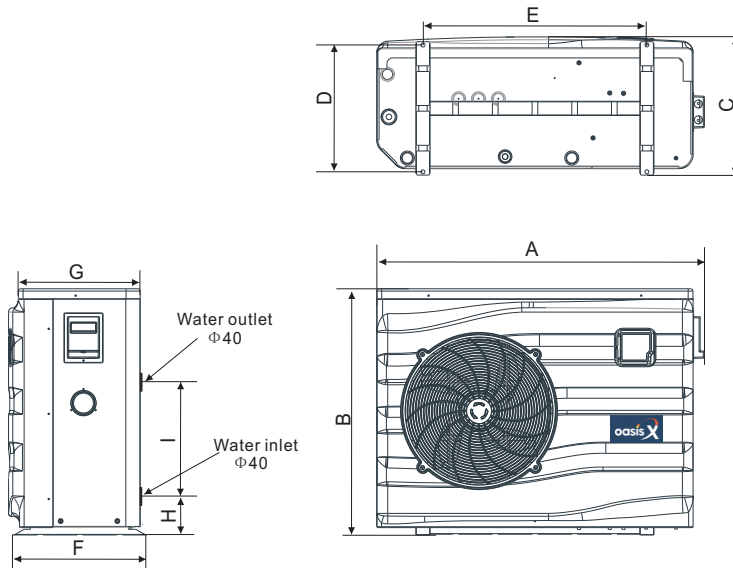

unit: mm

TYPE SIZE	Oasis X19/X24
A	1156
B	867
C	487
D	447
E	790
F	470
G	430
H	113
I	370

# 3.INSTALLATION AND CONNECTION

---

## 3.1 Installation illustration

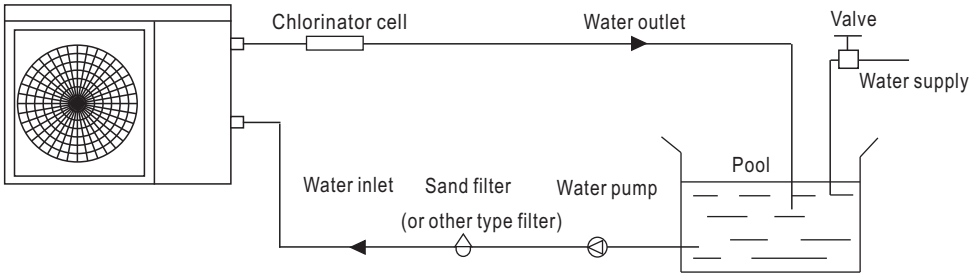

### Installation items:

The factory only provides the main unit and the water unit; the other items in the illustration are necessary spare parts for the water system, that provided by users or the installer.

### Attention:

Please follow these steps when using for the first time

1. Open valve and charge water.
2. Make sure that the pump and the water-in pipe have been filled with water.
3. Close the valve and start the unit.

ATTN: It is necessary that the water-in pipe is higher than the pool surface.

# 3.INSTALLATION AND CONNECTION

## 3.2 Swimming Pool Heat Pumps Location

The unit will perform well in any outdoor location provided that the following three factors are presented:

- 1. Fresh Air - 2. Electricity - 3. Pool filter piping

The unit may be installed virtually anywhere outdoors. For indoor pools please consult the supplier. Unlike a gas heater, it has no draft or pilot light problem in a windy area.

DO NOT place the unit in an enclosed area with a limited air volume, where the units discharge air will be re-circulated.

DO NOT place the unit to shrubs which can block air inlet. These locations deny the unit of a continuous source of fresh air which reduces it efficiency and may prevent adequate heat delivery.

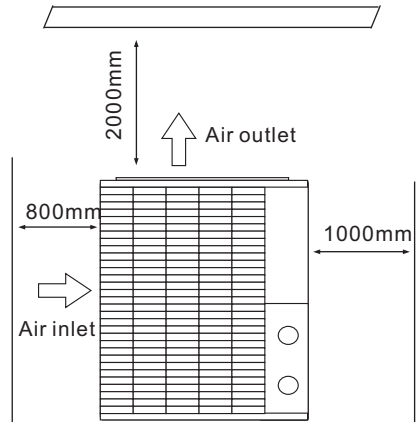
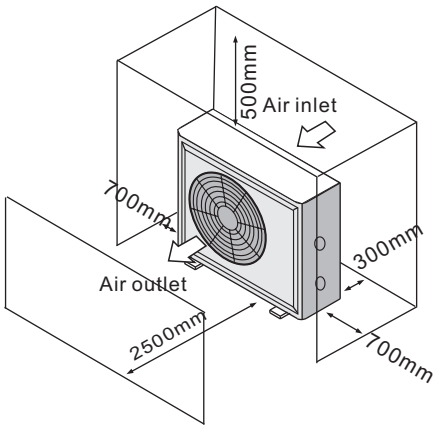

## 3.3 How Close To Your Pool?

Normally, the pool heat pump is installed within 7.5 metres of the pool. The longer the distance from the pool, the greater the heat loss from the piping. For the most part, the piping is buried. Therefore, the heat loss is minimal for runs of up to 15 meters (15 meters to and from the pump = 30 meters total), unless the ground is wet or the water table is high. A very rough estimate of heat loss per 30 meters is 0.6 kW-hour, (2000BTU) for every 5 °C difference in temperature between the pool water and the ground surrounding the pipe, which translates to about 3% to 5% increase in run time.



# 3. INSTALLATION AND CONNECTION

## 3.4 Swimming Pool Heat Pumps Plumbing

The Swimming Pool Heat Pumps exclusive rated flow titanium heat exchanger requires no special plumbing arrangements except bypass (please set the flow rate according to the nameplate). The water pressure drop is less than 10kPa at max. Flow rate. Since there is no residual heat or flame Temperatures, The unit does not need copper heat sink piping. PVC pipe can be run straight into the unit.

Location: Connect the unit in the pool pump discharge (return) line downstream of all filter and pool pumps, and upstream of any chlorinators, ozonators or chemical pumps.

Standard model have slip glue fittings which accept 32mm or 50 mm PVC pipe for connection to the pool or spa filtration piping. By using a 50 NB to 40NB you can plumb 40NB

Give serious consideration to adding a quick coupler fitting at the unit inlet and outlet to allow easy draining of unit for winterizing and to provide easier access should servicing be required.

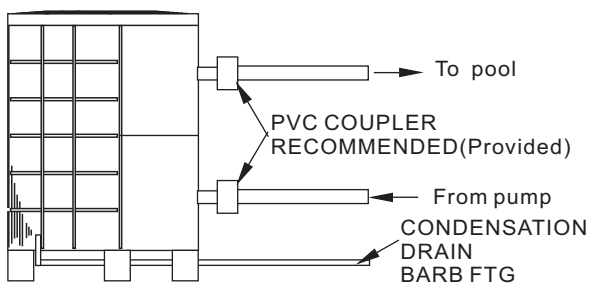

Condensation: Since the Heat pump cools down the air about 4 -5°C, water may condense on the fins of the horseshoe shaped evaporator. If the relative humidity is very high, this could be as much as several litres an hour. The water will run down the fins into the basepan and drain out through the barbed plastic condensation drain fitting on the side of the basepan. This fitting is designed to accept 20mm clear vinyl tubing which can be pushed on by hand and run to a suitable drain. It is easy to mistake the condensation for a water leak inside the unit.

NB: A quick way to verify that the water is condensation is to shut off the unit and keep the pool pump running. If the water stops running out of the basepan, it is condensation. AN EVEN QUICKER WAY IS to TEST THE DRAIN WATER FOR CHLORINE - if there is no chlorine present, then it's condensation.

# 3. INSTALLATION AND CONNECTION

---

## 3.5 Swimming Pool Heat Pumps Electrical Wiring

NOTE: Although the unit heat exchanger is electrically isolated from the rest of the unit, it simply prevents the flow of electricity to or from the pool water. Grounding the unit is still required to protect you against short circuits inside the unit. Bonding is also required.

The unit has a separate molded-in junction box with a standard electrical conduit nipple already in place. Just remove the screws and the front panel, feed your supply lines in through the conduit nipple and wire-nut the electric supply wires to the three connections already in the junction box (four connections if three phase). To complete electrical hookup, connect Heat Pump by electrical conduit, UF cable or other suitable means as specified (as permitted by local electrical authorities) to a dedicated AC power supply branch circuit equipped with the proper circuit breaker, disconnect or time delay fuse protection.

Disconnect - A disconnect means (circuit breaker, fused or un-fused switch) should be located within sight of and readily accessible from the unit. This is common practice on commercial and residential air conditioners and heat pumps. It prevents remotely-energizing unattended equipment and permits turning off power at the unit while the unit is being serviced.

## 3.6 Initial startup of the Unit

NOTE- In order for the unit to heat the pool or spa, the filter pump must be running to circulate water through the heat exchanger.

Start up Procedure - After installation is completed, you should follow these steps:

1. Turn on your filter pump. Check for water leaks and verify flow to and from the pool.
2. Turn on the electrical power supply to the unit, then press the key ON/OFF of wire controller. It should start in several seconds.
3. After running a few minutes make sure the air leaving the top(side) of the unit is cooler (Between 5-10 °C)
4. With the unit operating turn the filter pump off. The unit should also turn off automatically.
5. Allow the unit and pool pump to run 24 hours per day until desired pool water temperature is reached. When the water-in temperature reach setting, The unit just shuts off. The unit will now automatically restart (as long as your pool pump is running) when the pool temperature drops more than 2°C below set temperature.

Time Delay- The unit is equipped with a 3 minute built-in solid state restart delay included to protect control circuit components and to eliminate restart cycling and contactor chatter. This time delay will automatically restart the unit approximately 3 minutes after each control circuit interruption. Even a brief power interruption will activate the solid state 3 minute restart delay and prevent the unit from starting until the 5 minute countdown is completed. Power interruptions during the delay period will have no effect on the 3 minute countdown.

# 4. USAGE AND OPERATION

## 1. Function of controller

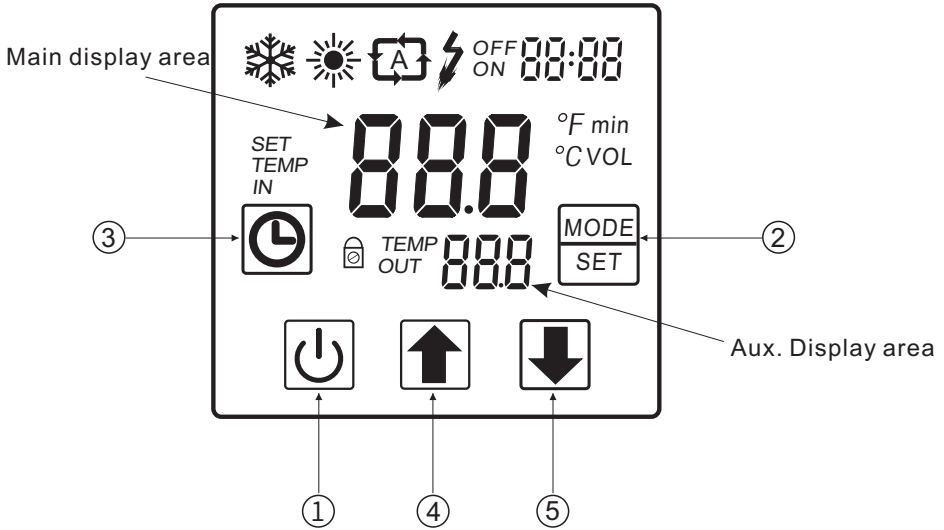





### 1) Button function

NO	Symbol	Name	Function
①		On/off	Press this button can start up or shut down the unit, cancel the current operation or back to the upper interface
②		Mode	Press this button can switch modes or save parameter setting.
③		Clock	Press this button can set the clock and timer
④		Up	Press this button can move up or increase parameter value.
⑤		Down	Press this button can move down or decrease the parameter value.

## 4. USAGE AND OPERATION

---



### 2) Display function

Symbol	Meaning	Function
	Cooling	It is showed when the unit in cooling mode.
	Heating	It is showed when the unit in heating mode and flashed in defrosting.
	Automatic	It is showed when the unit in automatic mode.
	Electric-heating	It is showed when the unit in electric-heating mode. (Swimming pool unit without this display)
ON	Timer on	It is showed when the unit sets the timer on
OFF	Timer off	It is showed when the unit sets the timer off
IN	Inlet water	It is showed when the main display area gives the inlet water temperature.(measured value)
OUT	Outlet water	It is showed when the AUX display area gives the outlet water temperature.(measured value)
TEMP	Temperature	It is showed when the main/AUX display area gives temperature
VOL	Flow	It is showed when the main display area gives the water flow value
min	Minute	It is showed when the main display area gives minute value
°F	Fahrenheit	It is showed when the main/AUX display area gives Fahrenheit value
°C	Centigrade	It is showed when the main/AUX display area gives centigrade value
SET	Parameter setting	It is showed when the parameter can be setted.
	Lock	It is showed when the keyboard is locked.

# 4. USAGE AND OPERATION

## 2. The controller usage

### 2.1 Starting up and shutting down

In the off interface, press "  " for 0.5s can start up the unit, and aux. display-area shows water outlet temperature; In the running interface, press "  " for 0.5s can shut down the unit and aux. display-area shows "OFF" .

Attention: the operation of Starting up and shutting down can only be done in the main interface. For example:

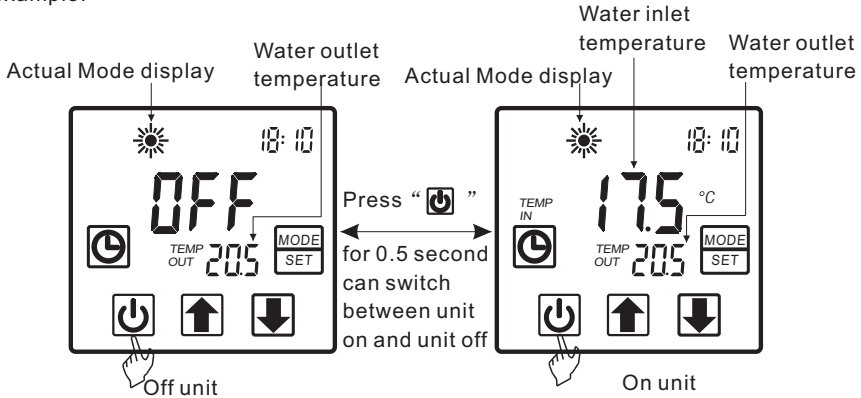

### 2.2 Modes switching

If it is cold/ heat unit, in the main interface, you can switch different modes of cooling, heating, auto mode by pressing "  " .

Attention: The modes switching is useless if the unit you buy is single-cold/ single-heat unit. For example:

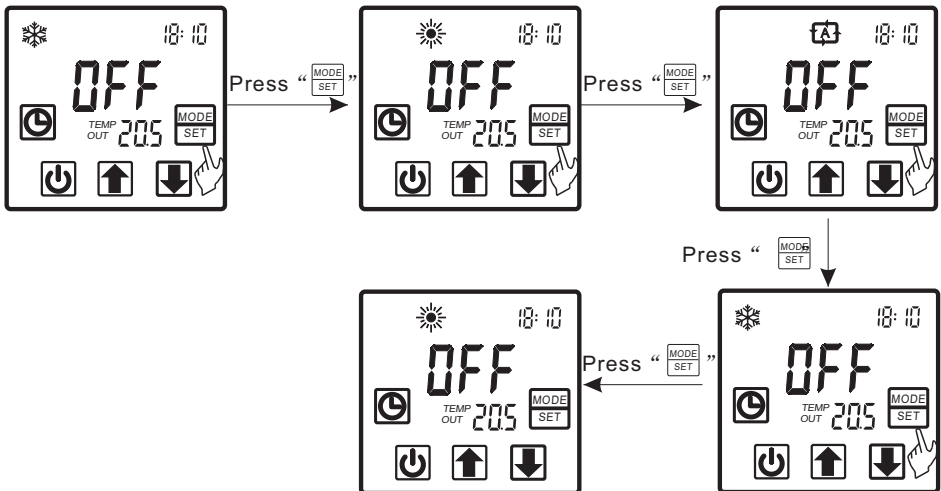

# 4. USAGE AND OPERATION

## 2.3 Temperature setting

In the main interface, press “

Press “

Press “

Attention: If there is no operation for 5s, system would remember parameter setting and back to the main interface.

For example:

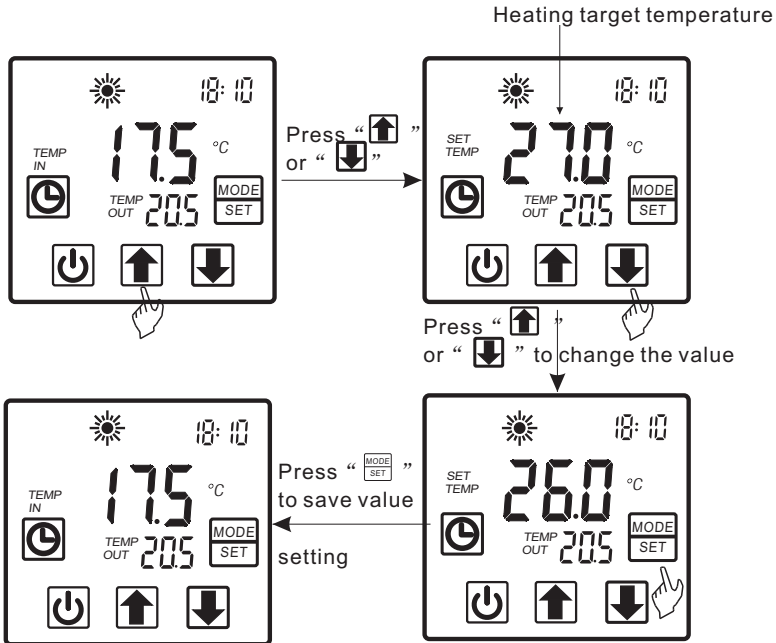

In the main interface, press “

At the same time, minute start to flashing , press “

Press “

Attention: If there is no operation for 5s system will remember parameter setting and back to the main interface.

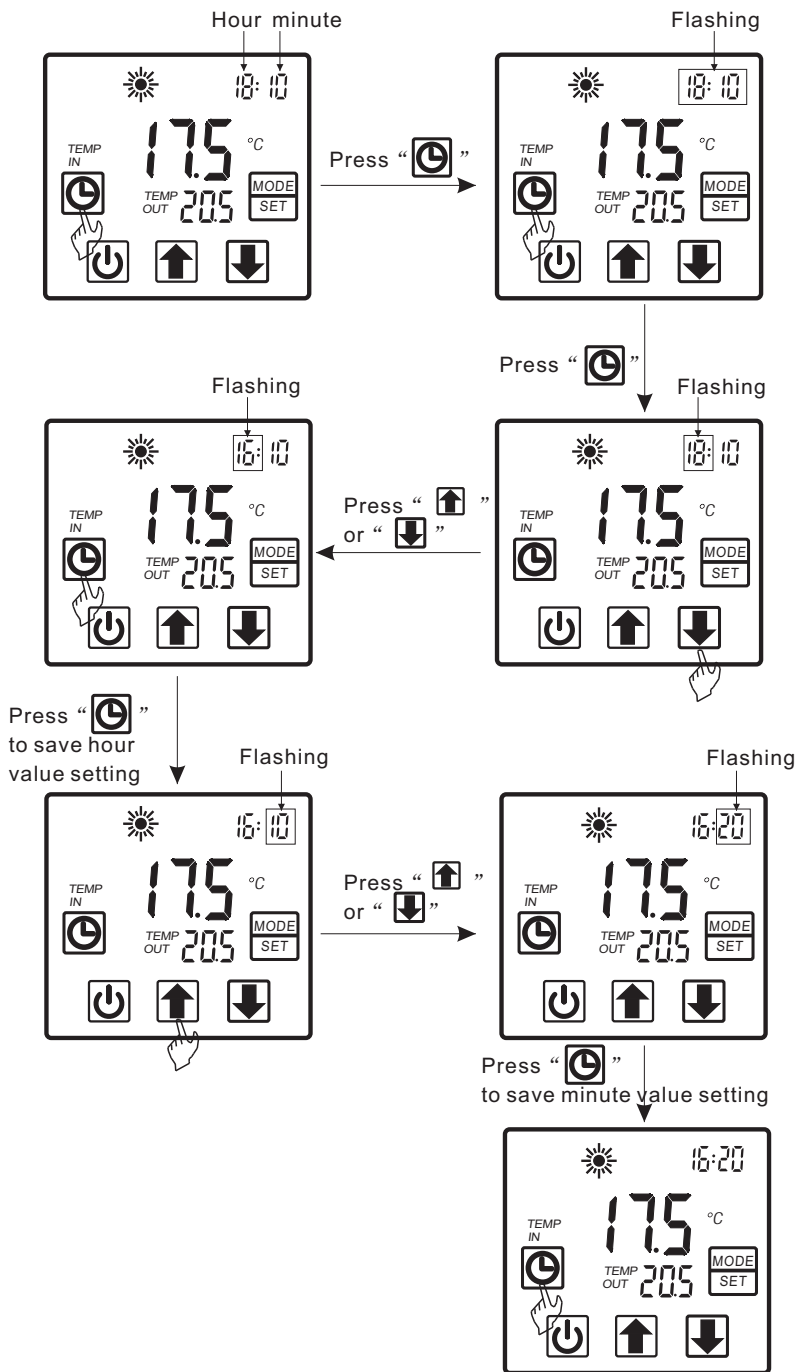

For example:

# 4. USAGE AND OPERATION



# 4. USAGE AND OPERATION

## 2.5 Timer setting

In the main interface, press “” hold on 2 seconds and "on" is flashing, at this time, you can set the timer on (means the unit timer is on) , then press “” again and hold on 2 seconds and "off" is flashes you can set the timer off (means the unit timer is off) .

If you want cancel the timer off, In the "off" flashing interface, press “” to cancel

Attention: 1) If there is no operation for 5s, system will remember clock setting and back to the main interface.

2) By pressing “” till the "off" flashing, you can set the timer off without timer on.

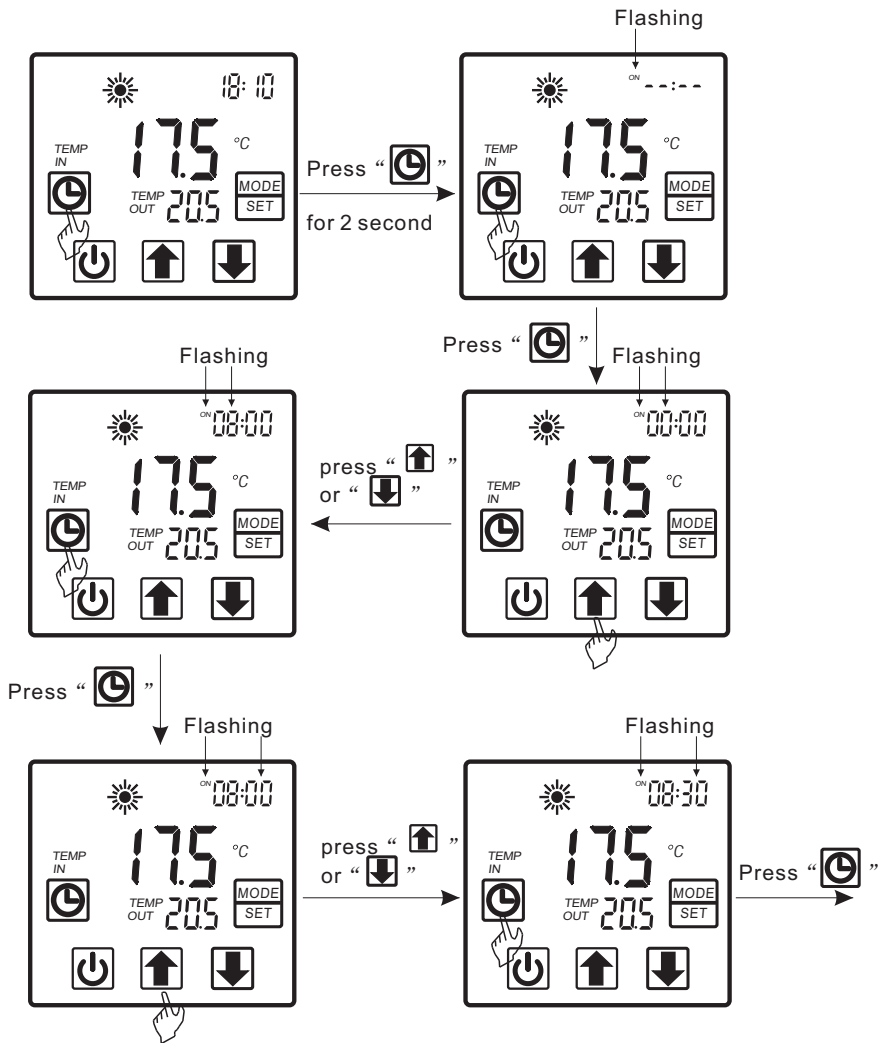



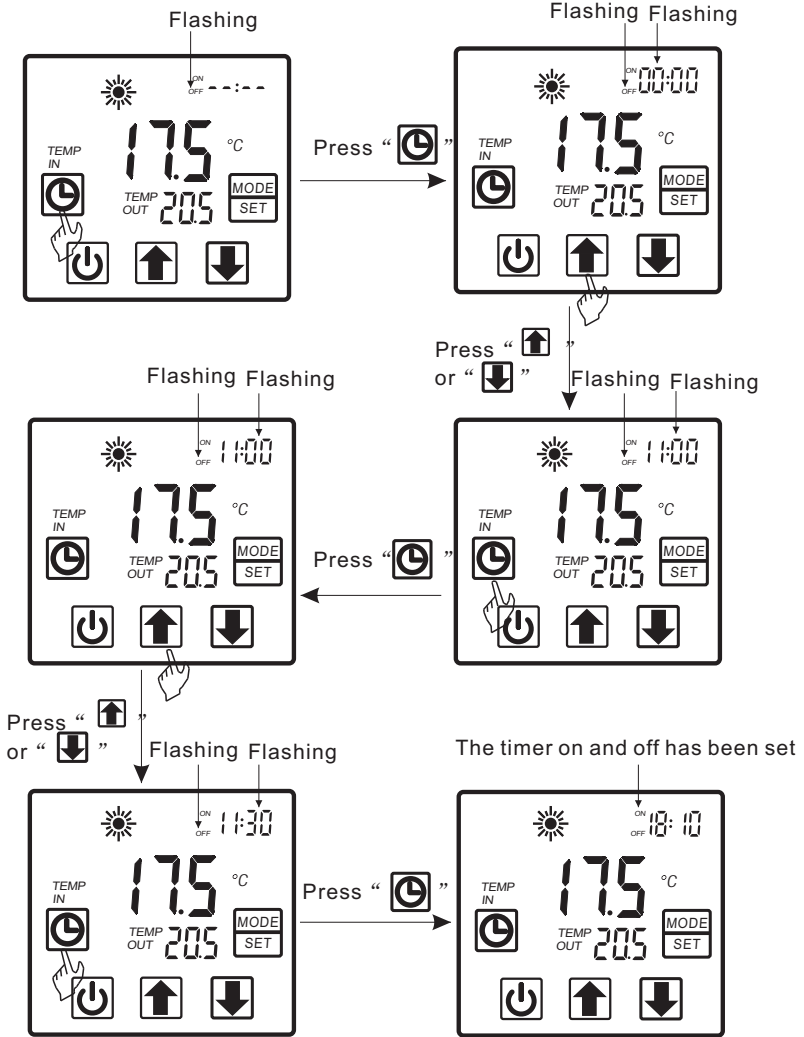

# 4. USAGE AND OPERATION



# 4. USAGE AND OPERATION

## 2.6 Cancel the timer setting

Press “” for 2s and "ON" is flashing, at this time, press “” to cancel the setting of timer on; It is the same way to cancel the setting of timer off .

For example:

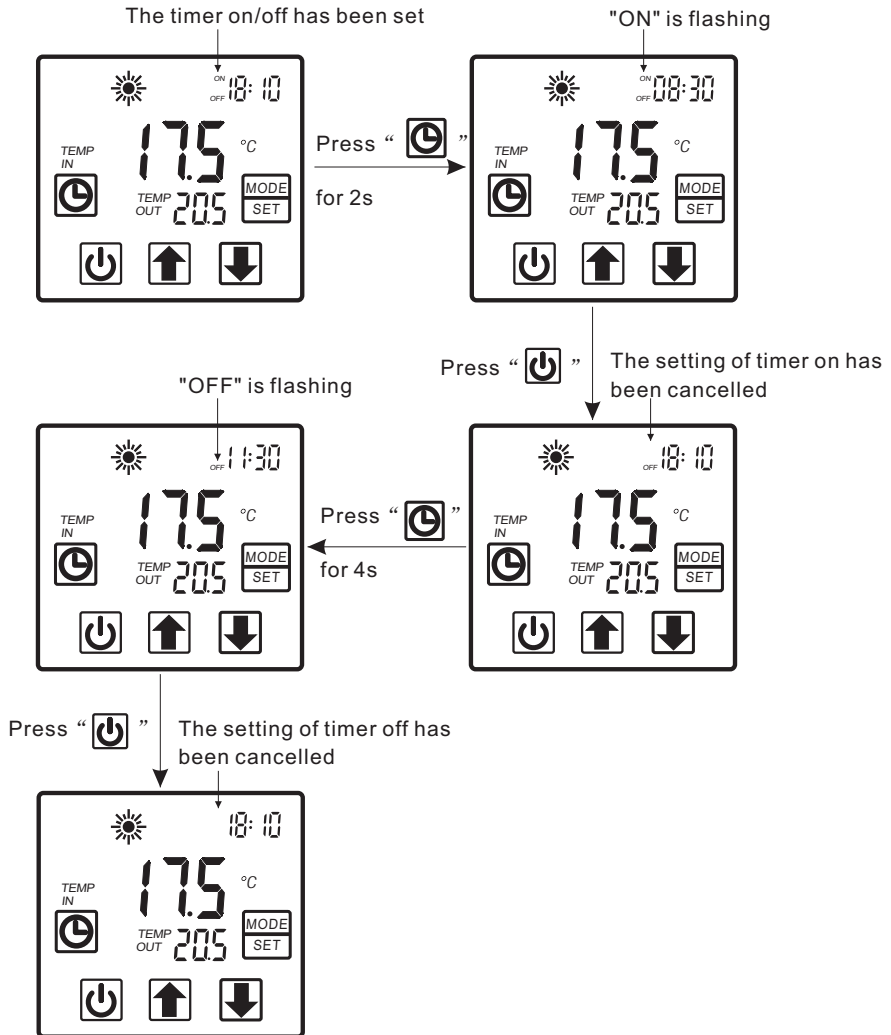

## 4. USAGE AND OPERATION

### 2.4 Keyboard lock

To avoid mis-operation, please lock the controller after parameter setting.

At the main interface, press “” for 5 seconds, the keyboard will be locked.

When the keyboard is locked, press “” for 5 seconds, the keyboard will be unlocked.

NOTES: When the unit is in alarming state, the key lock can be removed automatically.

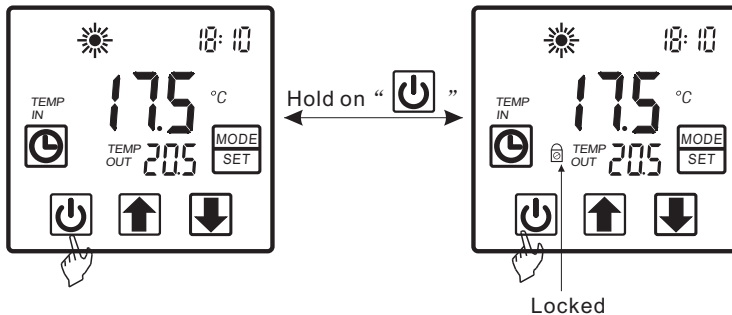

### 2.5 Malfunction display

There will be malfunction code showing on the controller screen when relative malfunction occurs.

You can refer to the malfunction table to find out the failure cause and solution.

For example:

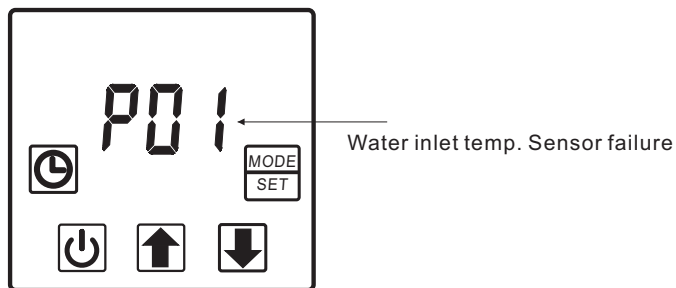

## 4. USAGE AND OPERATION

---

### 3. Parameter table

Meaning	Default	Remark
Heating inlet target temp.	28°C	Adjustable
Cooling inlet target temp.	28°C	Adjustable
Auto inlet target temp.	27°C	Adjustable

**Remark:**

The wire controller can display the temperature unit as "°F" or "°C" according to the unit Model you bought.

# 5. MAINTENANCE AND INSPECTION

## Malfunction Table

The common failure cause and solution.

Malfunction	Display	Canse	Solution
Water inlet temp. Sensor failure	P01	The water inlet temp. Sensor is open or short circuit	Check or change the water inlet temp. Sensor
Water outlet temp. Sensor failure	P02	The water outlet temp. sensor is open or short circuit	Check or change the water outlet temp. Sensor
Ambient temp. Sensor failure	P04	The ambient temp. sensor is open or short circuit	Check or change the ambient temp. Sensor
Pipe temp. Sensor failure	P05	The pipe temp. sensor is open or short circuit	Check or change the pipe temp. Sensor
Evaporator temp. Sensor failure	P07	The evaporator temp. Sensor is open or short circuit	Check or change the evaporator temp. Sensor
High pressure protect	E01	The exhaust pressure is high , high pressure switch action	Check high pressure switch and cooling return circuit
Low pressure protect	E02	The suction pressure is low, Low pressure switch action	Check low pressure switch and cooling return circuit
Flow switch failure	E03	No water or litter water in water system	Check the flow volume ,water pump is failure or not
Temp. is too much different between water-inlet and outlet	E06	Water flow volume not enough, Water system pressure difference is small	Check the flow volume, water system is jammed or not
Antifreezing under cooling mode	E07	Water flow volume not enough	Check the flow volume, water system is jammed or not
The primary anti-freezing protection start.	E19	Ambient temperature is too low	
The second anti-freezing protection start	E29	Ambient temperature is too low	
Communication failure	E08	Communication failure between remote wire controller and main board	Check the wire connection between remote wire controller and main board

# 6.APPENDIX

## 1.Connection of PCB illustration

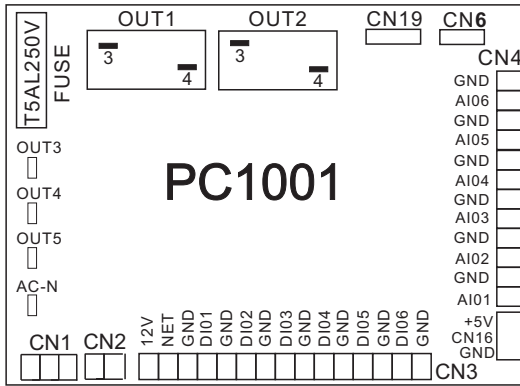



Connections explanation :

No.	Symbol	Meaning
1	OUT1	Compressor of system1 (220-230VAC)
2	OUT2	Water pump (220-230VAC)
3	OUT3	4way valve (220-230VAC)
4	OUT4	High speed of fan motor (220-230VAC)
5	OUT5	Low speed of fan motor (220-230VAC)
6	AC-N	Neutral wire
7	NET GND 12V	Wire controller
8	DI01 GND	On/Off Switch(input)(no use)
9	DI02 GND	Flow switch (input)( normal close)
10	DI03 GND	Low pressure protect
11	DI04 GND	High pressure protect
12	DI05 GND	No use
13	DI06 GND	No use
14	AI01 GND	Suction temp.(input)
15	AI02 GND	Water in temp.(input)
16	AI03 GND	Water out temp.(input)
17	AI04 GND	Temp. Of coil ( input)
18	AI05 GND	Ambient temp.(input)
19	AI06 GND	Adjustable fan speed/Exhaust temperature
20	CN1	Primary transformer
21	CN2	Secondary transformer
22	CN6	Without use
23	CN19	Electronic expansion valve
24	5V CN16 GND	Flow meter

## 6.APPENDIX

---

### Caution & Warning

1. The unit can only be repaired by qualified installer centre personnel or an authorised dealer. (for Europe market)
  2. This appliance can used by children aged from 8 years and above and persons with reduced physical, sensory or mental capabilities or lack of experience and knowledge if they have been given supervision or instruction concerning use of the appliance in a safe way and understand the hazards involved.
  3. Please make sure that the unit and power connection have good earthing, otherwise may cause electrical shock.
  4. If the supply cord is damaged, it must be replaced by the manufacturer or our service agent or similarly qualified person in order to avoid a hazard.
  5. Directive 2002/96/EC (WEEE):  
The symbol depicting a crossed-out waste bin that is underneath the appliance indicates that this product, at the end of its useful life, must be handled separately from domestic waste, must be taken to a recycling centre for electric and electronic devices or handed back to the dealer when purchasing an equivalent appliance.
  6. Directive 2002/95/EC (RoHs): This product is compliant with directive 2002/95/EC (RoHs) concerning restrictions for the use of harmful substances in electric and electronic devices.
  7. The unit CANNOT be installed near the flammable gas. Once there is any leakage of the gas , fire can be occur.
  8. Make sure that there is circuit breaker for the unit, lack of circuit breaker can lead to electrical shock or fire.
  9. The heat pump located inside the unit is equipped with an over-load protection system. It does not allow for the unit to start for at least 3 minutes from a previous stoppage.
  10. The unit can only be repaired by the qualified personnel of an installer center or an authorized dealer. (for North America market)
  11. Installation must be performed in accordance with the NEC/CEC by authorized person only. (for North America market)
  12. USE SUPPLY WIRES SUITABLE FOR 75°C.
  13. Caution: Single wall heat exchanger, not suitable for potable water connection.
  14. Children shall not play with the appliance .Cleaning and user maintenance shall not be made by children without supervision.
- 
15.  Notes on environmental protection.
  16. This product may be at the end of his life rather than the normal household waste will be sonderm at a collection point for the recycling of electrical and electronic equipment will be delivered. The symbol on the product, the instruction manual or packaging recalls.
  17. The materials are recycled, according to their identification. With the reuse of recycling or other forms of recovery of waste afford a important contribution to protect our environment.
  18. Please ask at the municipal disposal of the competent authority.

## 6.APPENDIX

### (2) Cable specification

#### 1. Single phase unit

Nameplate maximum current	Phase line	Earth line	MCB	Creepage protector	Signal line
No more than 10A	$2 \times 1.5\text{mm}^2$	$1.5\text{mm}^2$	20A	30mA less than 0.1 sec	$n \times 0.5\text{mm}^2$
10~16A	$2 \times 2.5\text{mm}^2$	$2.5\text{mm}^2$	32A	30mA less than 0.1 sec	
16~25A	$2 \times 4\text{mm}^2$	$4\text{mm}^2$	40A	30mA less than 0.1 sec	
25~32A	$2 \times 6\text{mm}^2$	$6\text{mm}^2$	40A	30mA less than 0.1 sec	
32~40A	$2 \times 10\text{mm}^2$	$10\text{mm}^2$	63A	30mA less than 0.1 sec	
40~63A	$2 \times 16\text{mm}^2$	$16\text{mm}^2$	80A	30mA less than 0.1 sec	
63~75A	$2 \times 25\text{mm}^2$	$25\text{mm}^2$	100A	30mA less than 0.1 sec	
75~101A	$2 \times 25\text{mm}^2$	$25\text{mm}^2$	125A	30mA less than 0.1 sec	
101~123A	$2 \times 35\text{mm}^2$	$35\text{mm}^2$	160A	30mA less than 0.1 sec	
123~148A	$2 \times 50\text{mm}^2$	$50\text{mm}^2$	225A	30mA less than 0.1 sec	
148~186A	$2 \times 70\text{mm}^2$	$70\text{mm}^2$	250A	30mA less than 0.1 sec	
186~224A	$2 \times 95\text{mm}^2$	$95\text{mm}^2$	280A	30mA less than 0.1 sec	

#### 2. Three phase unit

Nameplate maximum current	Phase line	Earth line	MCB	Creepage protector	Signal line
No more than 10A	$3 \times 1.5\text{mm}^2$	$1.5\text{mm}^2$	20A	30mA less than 0.1 sec	$n \times 0.5\text{mm}^2$
10~16A	$3 \times 2.5\text{mm}^2$	$2.5\text{mm}^2$	32A	30mA less than 0.1 sec	
16~25A	$3 \times 4\text{mm}^2$	$4\text{mm}^2$	40A	30mA less than 0.1 sec	
25~32A	$3 \times 6\text{mm}^2$	$6\text{mm}^2$	40A	30mA less than 0.1 sec	
32~40A	$3 \times 10\text{mm}^2$	$10\text{mm}^2$	63A	30mA less than 0.1 sec	
40~63A	$3 \times 16\text{mm}^2$	$16\text{mm}^2$	80A	30mA less than 0.1 sec	
63~75A	$3 \times 25\text{mm}^2$	$25\text{mm}^2$	100A	30mA less than 0.1 sec	
75~101A	$3 \times 25\text{mm}^2$	$25\text{mm}^2$	125A	30mA less than 0.1 sec	
101~123A	$3 \times 35\text{mm}^2$	$35\text{mm}^2$	160A	30mA less than 0.1 sec	
123~148A	$3 \times 50\text{mm}^2$	$50\text{mm}^2$	225A	30mA less than 0.1 sec	
148~186A	$3 \times 70\text{mm}^2$	$70\text{mm}^2$	250A	30mA less than 0.1 sec	
186~224A	$3 \times 95\text{mm}^2$	$95\text{mm}^2$	280A	30mA less than 0.1 sec	

When the unit will be installed at outdoor, please use the cable which can against UV.



# 6. APPENDIX

## 6.2 Explosive view of the unit

Model: Oasis X19

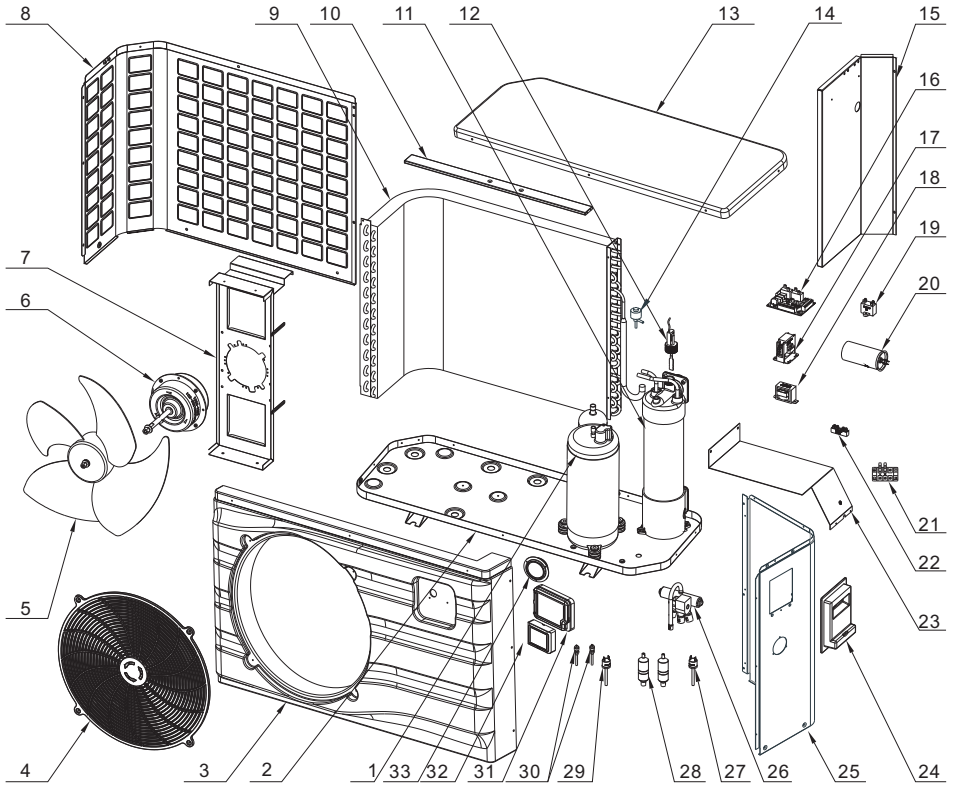

No.	Code	Name	Quantity	No.	Code	Name	Quantity
1	20000-110278	Compressor	1	19	2000-3509	Fan motor capacitor	1
2	32009-210606	Chassis	1	20	2000-3510	Compressor capacitor	1
3	32009-210294	Front panel	1	21	2000-3920	Terminal-3	1
4	20000-220169	Fan motor net	1	22	2000-3909	Terminal-2	1
5	20000-270004	Axial fan	1	23	32009-210117	Electrical box	1
6	20000-330134	Fan motor	1	24	20000-220247	Handle	1
7	32009-210204	Fan motor holder	1	25	32009-210605	Right panel	1
8	32009-210253	Left panel	1	26	2004-1437	4-way reverse valve	1
9	32009-120021	Evaporator	1	27	20000-360157	Pressure switch	1
10	32009-210025	Supporting panel	1	28	2004-1444	Filter	2
11	32008-120079	Titanium heat exchanger	1	29	2001-3605	Pressure switch	1
12	20000-360005	Water flow switch	1	30	20000-140150	Needle valve	2
13	32009-210295	Top cover	1	31	20000-220068	Waterproof cover	1
14	20000-140451	Electronic expansion valve	1	32	72200086	LCD	1
15	32009-210220	Middle panel	1	33	20000-280006	Pressure gauge	1
16	72200053	Pc1001 PCB controller	1				
17	2000-3676	Relay	1				
18	20000-370003	Transformer	1				

# 6. APPENDIX

## 6.2 Explosive view of the unit

Model: Oasis X24

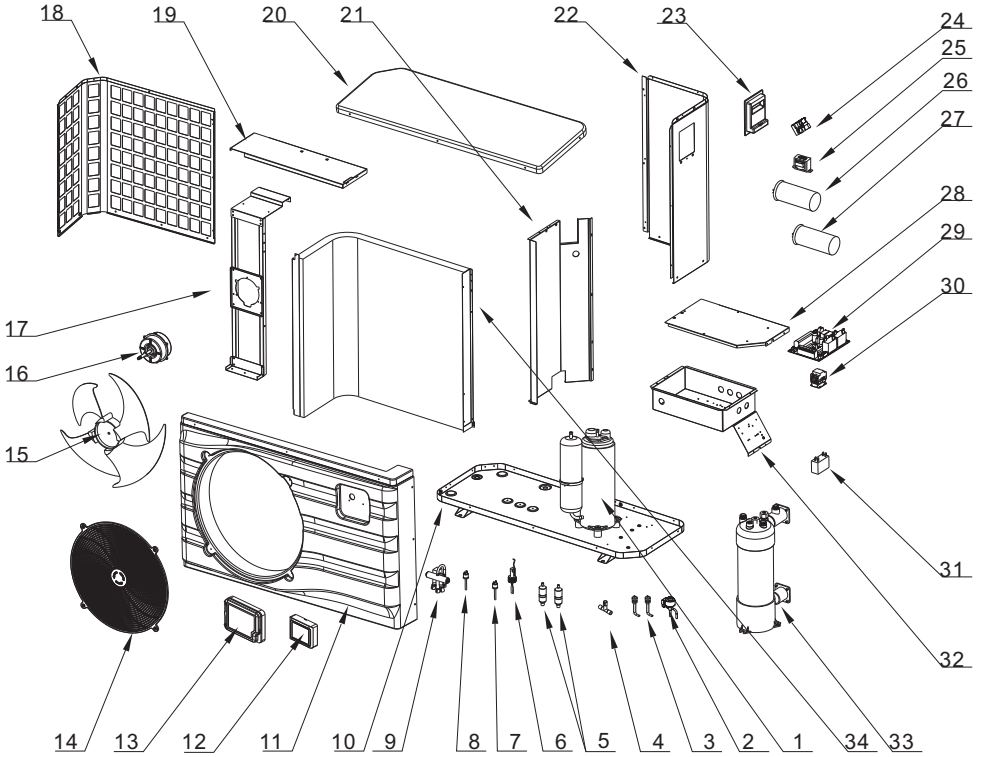

No.	Code	Name	Quantity	No.	Code	Name	Quantity
1	20000-110112	compressor	1	18	32009-210253	Back network component	1
2	20000-140442	Electronic expansion valve	1	19	32009-210025	Support plate	1
3	20000-140153	Needle valve	2	20	32009-210250	Top cover	1
4	2000-1460	Three links	2	21	32010-210019	Middle partition	1
5	2004-1444	filter	2	22	32009-210249	Right side panel	1
6	20000-360005	Flow switch	1	23	20000-220249	Junction box	1
7	2000-3603	Pressure Switch	1	24	2000-3909	2-position terminal block	2
8	2001-3605	Pressure Switch	1	25	20000-370003	Power Transformers	1
9	2001-1491	Four-way valve	1	26	2000-3524	Press capacitor	1
10	32009-210247	Chassis assembly	1	27	2000-3510	Press capacitor	1
11	32009-210294	Front box	1	28	32009-210118	Electrical box cover	1
12	72200086	CM106	1	29	72200118	Pc1001	1
13	20000-220068	Waterproof box	1	30	20000-360007	Single-phase AC contactor	1
14	20000-220169	Plastic fan net	1	31	2000-3509	Fan capacitor	1
15	20000-270004	Axial fan blade	1	32	32009-210021	Electrical box	1
16	20000-330134	Axial flow motor	1	33	32010-120012	Titanium tube heat exchanger	1
17	32010-210020	Motor bracket	1	34	32010-120016	Finned heat exchanger	1





#### Correct Disposal of this product

This marking indicates that product should not be disposed with other household wastes throughout the EU. To prevent possible harm to the environment to human health from uncontrolled waste disposal, recycle it responsibly to promote the sustainable reuse of material resources. To return your used device, please use the return and collection systems or contact the retailer where the product was purchased. They can take this product for environmental safe recycling.