

WIFI Module

USER'S MANUAL

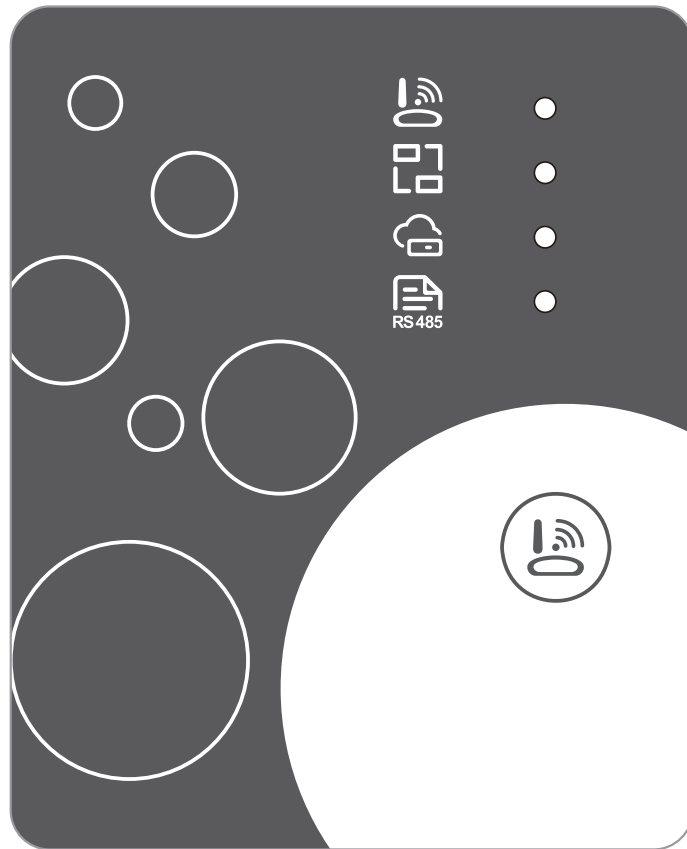

Please read this user's manual carefully before use
Please keep this user's manual properly

User Privacy Instructions

We take your privacy very seriously and we promise to inform you how we use the data. Users' private data, such as mailboxes, address, before uploading to the cloud, we will get your permission, and we will work hard to protect your data security.

Description

- Receive data signal from cloud server and transmit to the main device;
- Receive data signal from main device and transmit to cloud server;
- To achieve remote upgrade the WIFI module baseplate MCU by cloud server;
- To achieve the remote upgrade of the main device by WIFI module baseplate MCU.

Technical Parameters

OPERATING VOLTAGE: DC8V~12V (Recommended value 12V)

OPERATING CURRENT: Max. recurrent peak 1A, average standby current 50mA

TEMP. RANGE: Operating Temp.: -30℃~+70℃; Storage Temp.: -40℃~+85℃

LED INDICATOR LIGHT:

4 lights, Network configuration indicator, router connection indicator, cloud server connection indicator, 485 communication indicator;

DIMENSION(L×W×H): 78mm×63mm×24mm

Installation

- There is a magnet on the back of the WIFI module, it can be installed indoors or outdoors, and avoid direct sunlight;
- Please scan the following QR code to download APP;



Functional Description

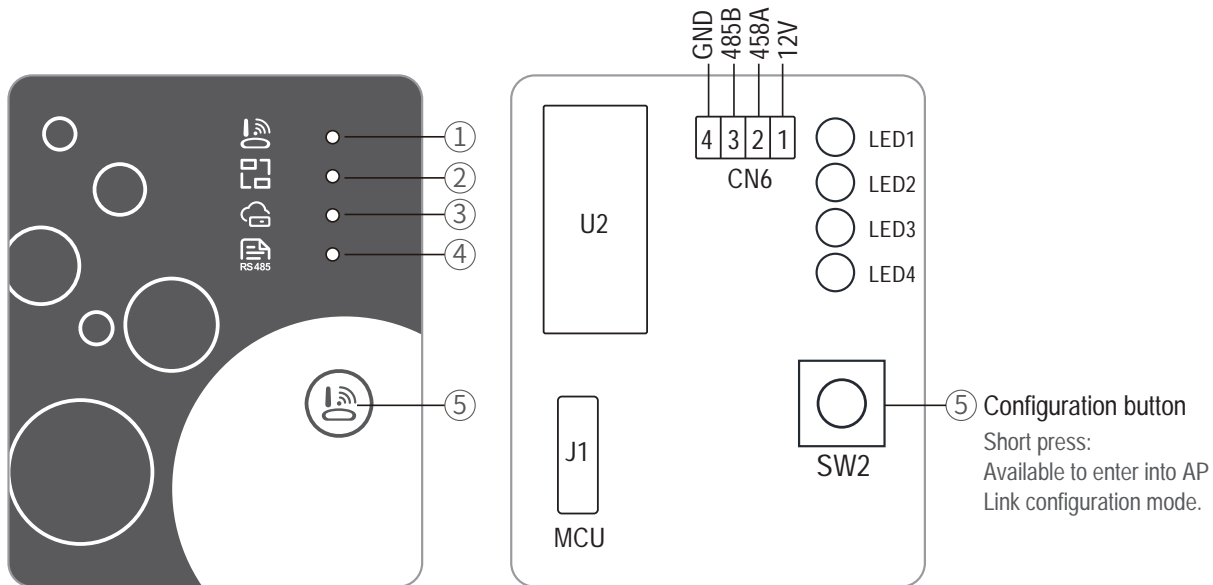

ITEM	NAME	LONG LIGHT	SLOW FLASH	EXTINGUISH
①	Network configuration indicator	Configuring Network	SmartLink configuring	Done
②	Router connection indicator	Normal	Abnormal	----
③	Cloud server connection indicator	Normal	Abnormal	----
④	485 communication indicator	Normal	Abnormal	----

Account Login

Use email address and password to register, login or reset the password.



Fig.2 Account Registration interface

Fig.1 Login interface

Fig.3 Forgot Password interface

1. Account Registration: To register an account, click ① (Fig.1) to jump to the Account Registration interface, fill in the relevant information and click ② to receive verification code, while completed the application information, click ③ to read the details of the Privacy Policy, then click ④ to agree, and click ⑤, registration is done.

Please note, the valid time of one verification code is 15min, please fill in the verification code within 15min, otherwise you need to ask for a new one.

2. Log in: Follow the instructions on the page(Fig.1), enter your registered email address and password, click ⑥ and jump to device list;

3. Forgot Password: While forget your password, click ⑦ (Fig.1), jump to the Forgot Password interface (Fig.3). Follow the instructions on the page, fill in the relevant informations, click ⑧ to receive verification code from your mailbox, click ⑨ to confirm and password reset is done.

Add Device

After log in, displays My Device interface (Fig. 4) , follow the instruction to add WIFI or DTU.

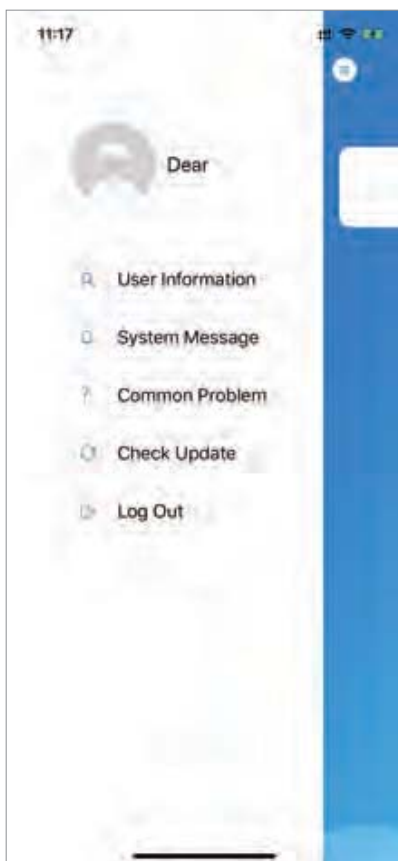

Fig.5 The left-hand menu



Fig.4 My Device interface

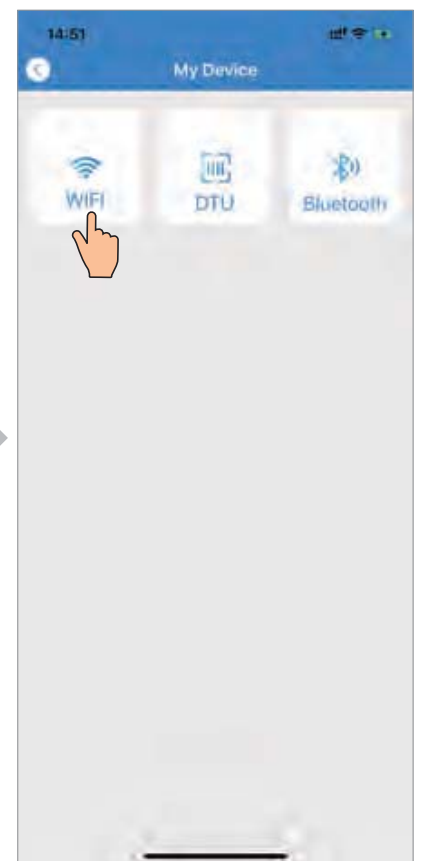

Fig.6 Add Device interface

WIFI Configure Network

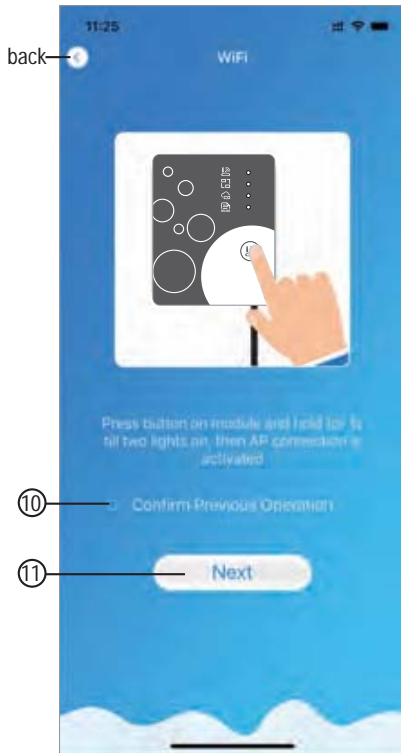

Fig.7 WIFI Module On interface



Fig.8 Enter password interface



Fig.9 Connect specified WIFI

1. Follow the instructions on the page (Fig.7), press button on module and hold for 1s till two lights on, then AP connection is activated, click ⑩ to confirm, click ⑪ to turn the page;
2. Click ⑫ to enter the WIFI password for the current connection, click ⑬ to confirm;
3. Jump to system settings, connect specified WIFI, click ⑭ to select the "Smart_AP_xxx", click ⑮ to popup window(Fig.10), follow the instruction and then jump to WIFI setting interface(Fig.11);

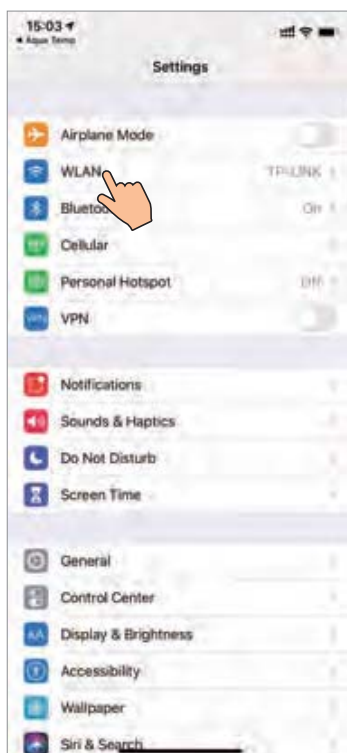

Fig.10 Setting interface



Fig.11 WIFI setting interface

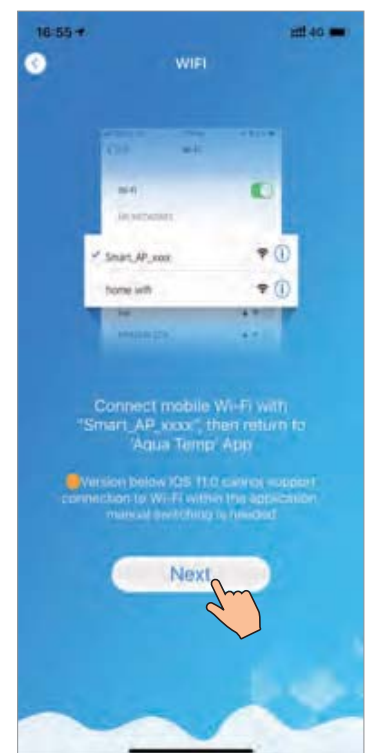

Fig.12 Connect specified WIFI

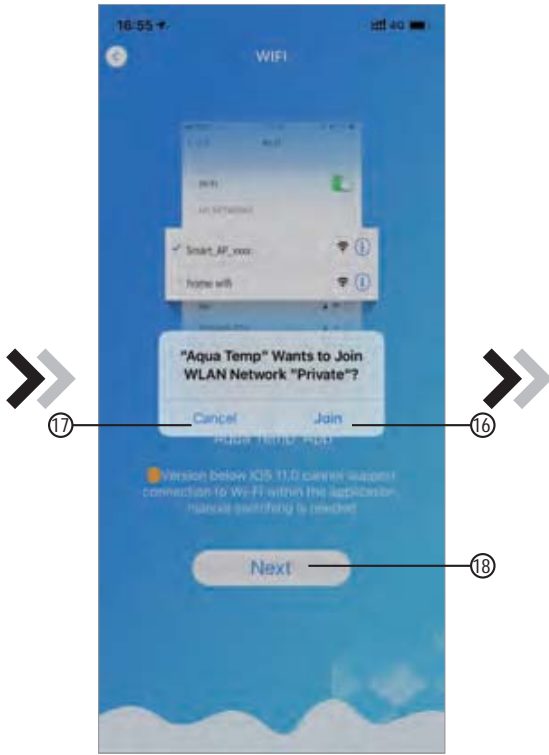

Fig.13 Configure Network interface

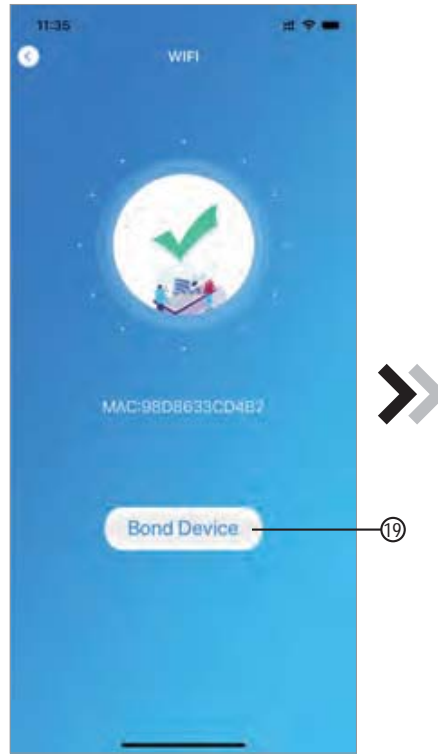

Fig.14 Bond Device interface

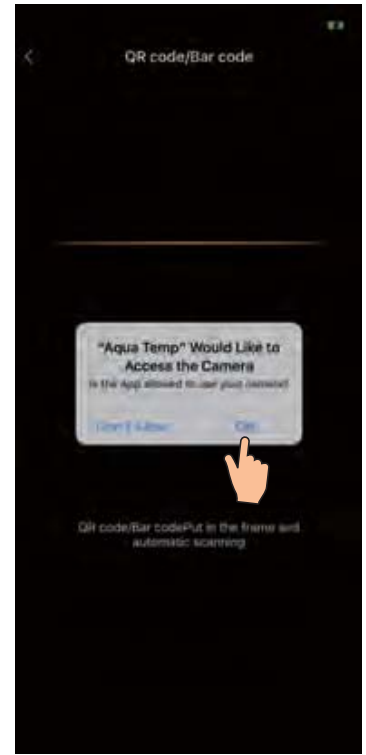

Fig.15 Scanning interface

4. Slide the page back to configure network interface (Fig. 12), click ⑩ to join WLAN Network, click ⑪ to cancel, click ⑫ to turn next page(Fig. 13); click ⑬ to bond device (Fig. 14);
5. Click “OK” to allow this APP to use the camera for scanning the barcode on heat pump unit (Fig.15); click “OK”, device bond is done (Fig.16);
6. After WIFI and DTU bonding is done, and jump back to My Device(Fig. 17).



Fig.16 Bond device done interface

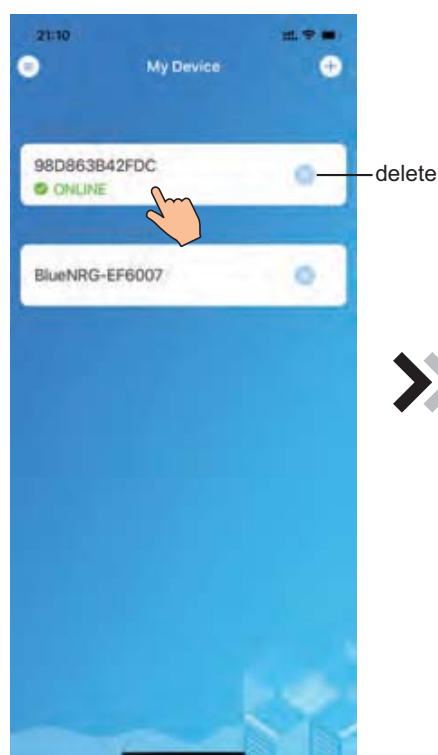

Fig.17 Device management interface

Device Management

Device management operations are as below :

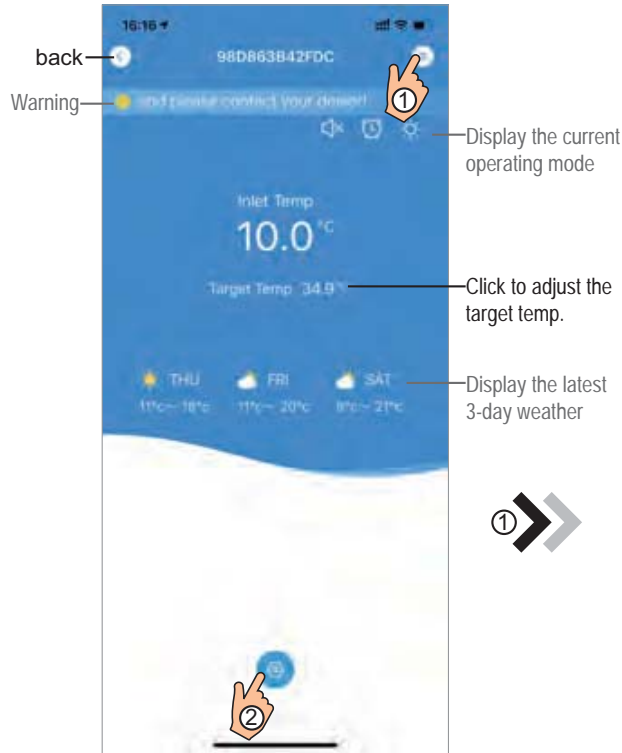

Fig.18 Device Main interface

Fig.19 The right-hand menu interface

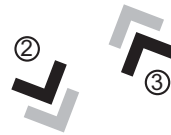

Fig.21 Timing Settings interface

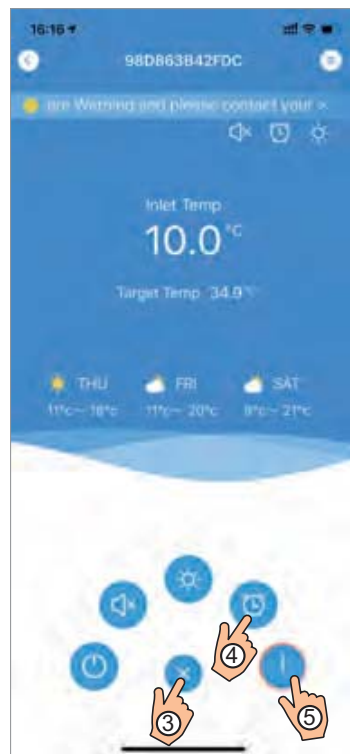

Fig.20 Device Main interface

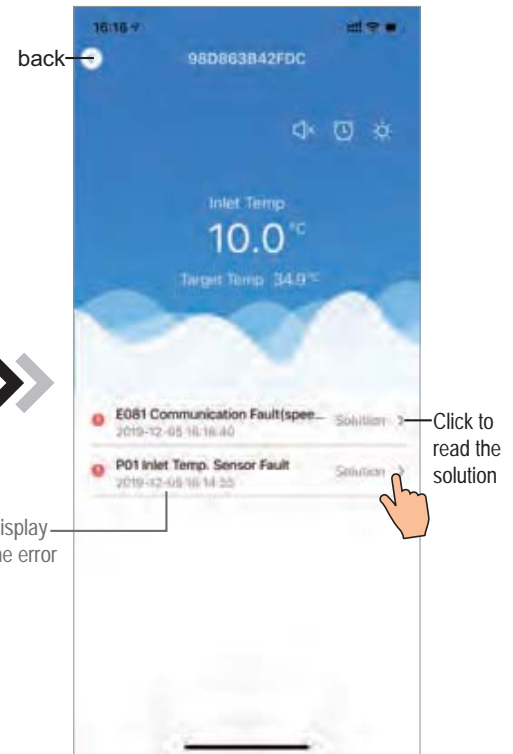











Fig.22 Troubleshooting interface

ICON	NAME	FUNCTIONS
	ON/ OFF	Click it to turn on/ off the unit
	Silent Mode Off	Display silent mode off, click it to activate the silent mode
	Silent Mode On	Display silent mode on, click it to turn off the silent mode
	Mode shift	Mode changing: Cooling--Heating--Auto
	Cooling	Display Cooling mode, click it to change operating mode
	Heating	Display Heating mode, click it to change operating mode
	Auto	Display Auto mode, click it to change operating mode
	Timing settings	Click it to jump to the timer on/ off and mute timer setting interface
	Troubleshooting	Click it to jump to the troubleshooting interface
	Menu	Click to unfold or collapse the menu